

Dogs

The dogs I know
Have many shapes.
For some are big and tall,
And some are long,
And
Some
Are thin,
And some are fat and small.
And some are little bits of fluff
And have no shape at all.

Marchette Gaylord Chute



Help the dog find its owner.



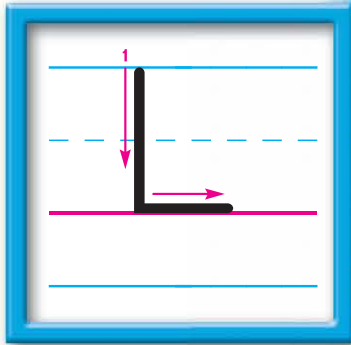

Trace and write.

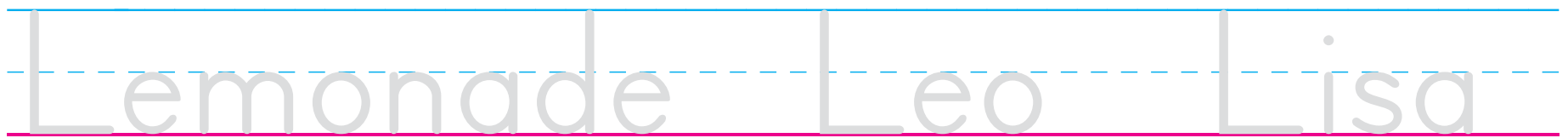
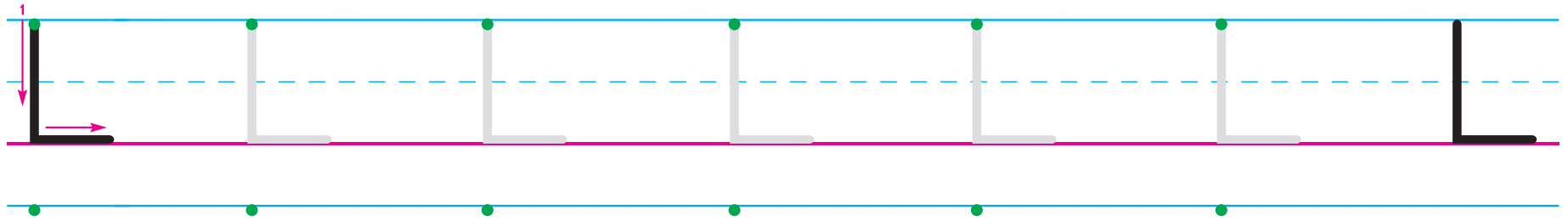

Directions:

Discuss the picture on the page. Help students identify **L** in the word on the sign.

Stroke description to guide letter formation at home:

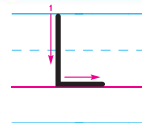

1. Pull down straight. Slide right.

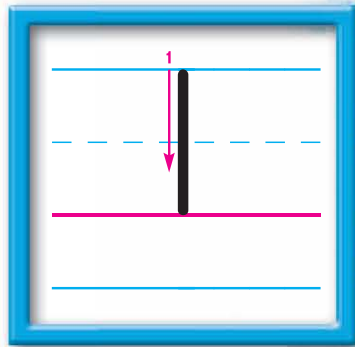

Trace and write.

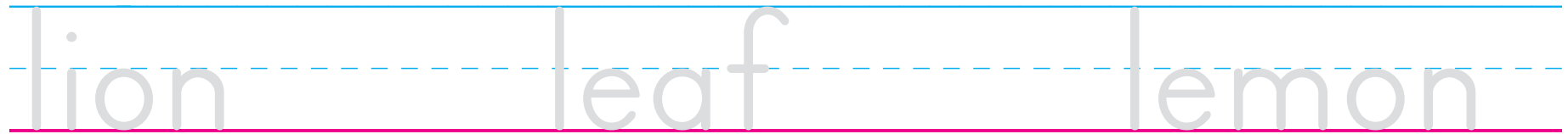
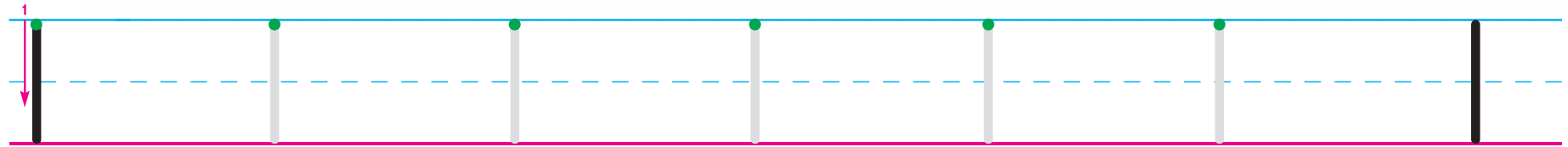

Directions:

Discuss the picture on the page.
Help students identify **l** in the words that name the pictures.

Stroke description to guide letter formation at home:

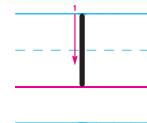

l. Pull down straight.

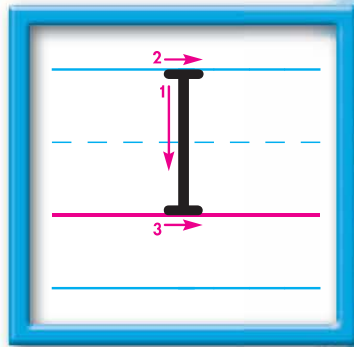

Trace and write.

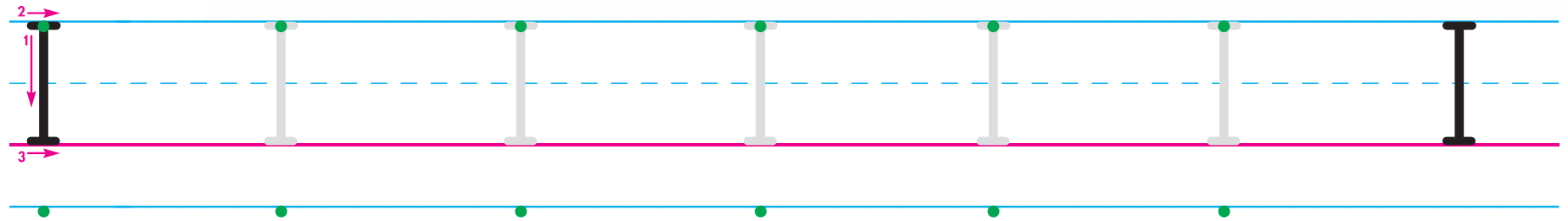

Directions:

Discuss the picture on the page. Help students identify **I** in the words on the banner.

Stroke description to guide letter formation at home:

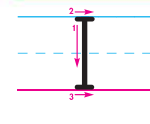
- 
1. Pull down straight. Lift.
 2. Slide right. Lift.
 3. Slide right.

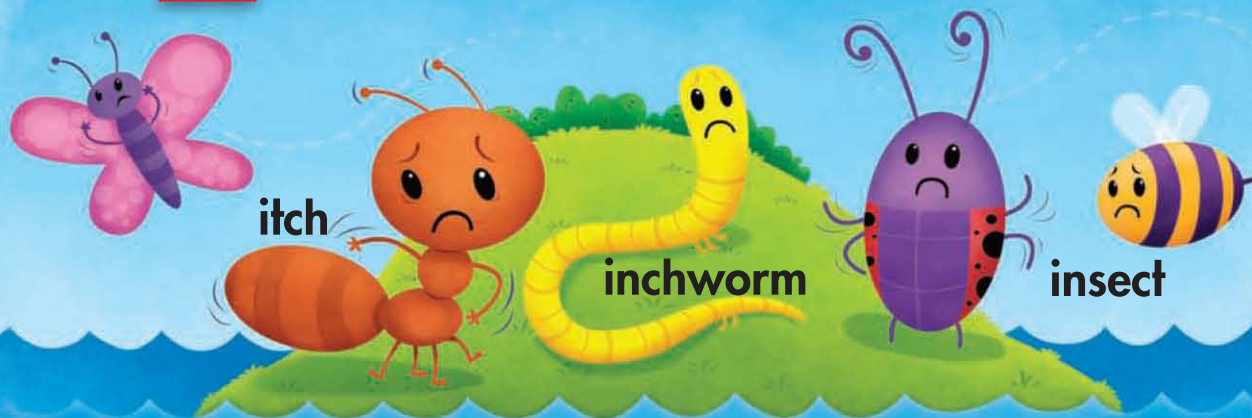
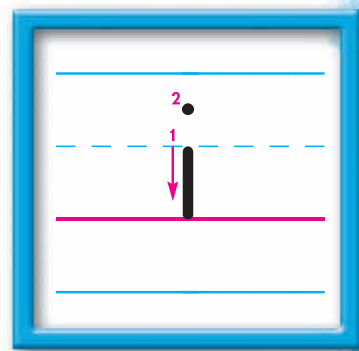

Trace and write.

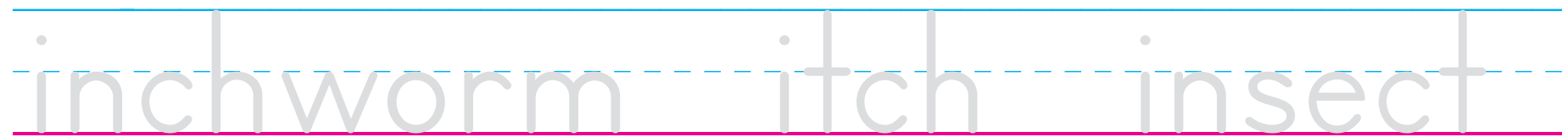
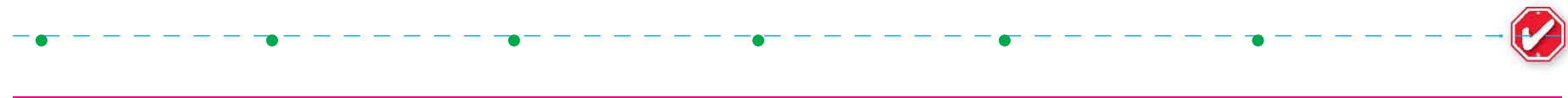
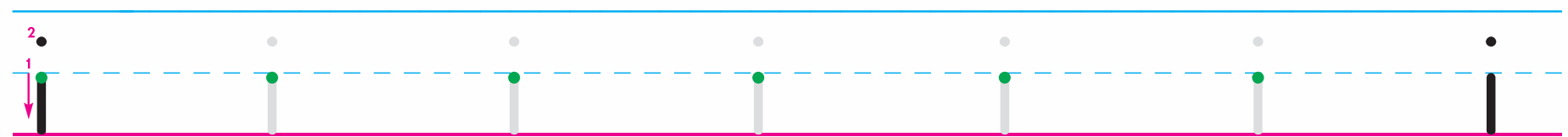

Directions:

Discuss the picture on the page.
Help students identify **i** in the words that name the pictures.

Stroke description to guide letter formation at home:

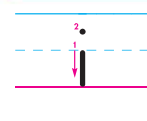
- 
1. Pull down straight. Lift.
 2. Dot.

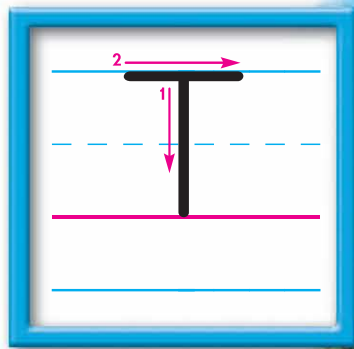

Trace and write.

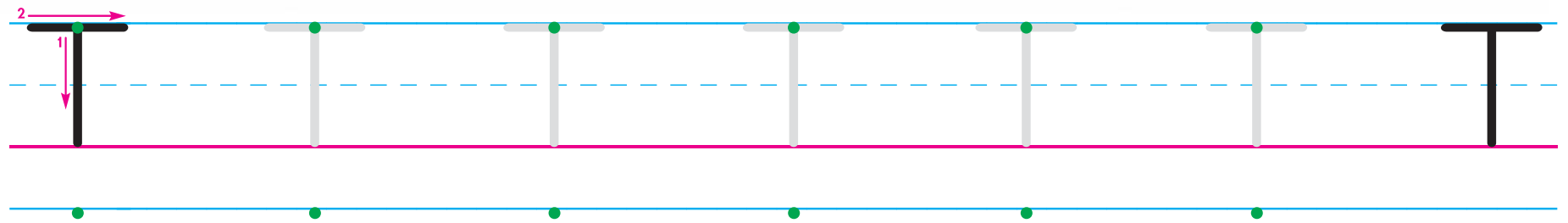

Directions:

Discuss the picture on the page.
Help students identify T in the words in the picture.

Stroke description to guide letter formation at home:

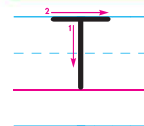

1. Pull down straight. Lift.
2. Slide right.

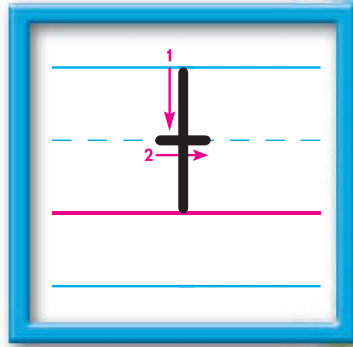

Trace and write.

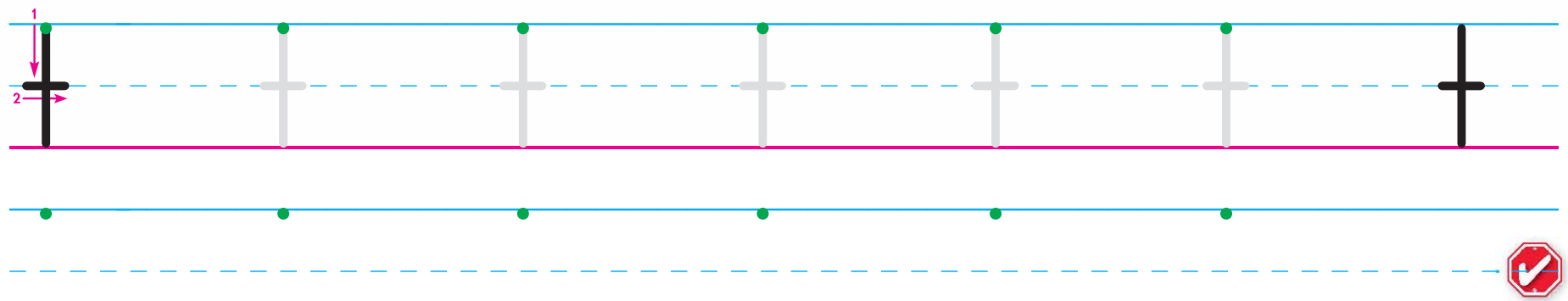

Directions:
Discuss the picture on the page.
Help students identify t in the words that name the pictures.

Stroke description to guide letter formation at home:

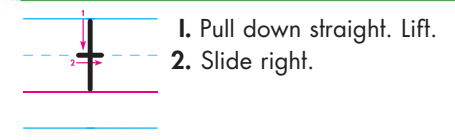



Write the letters.

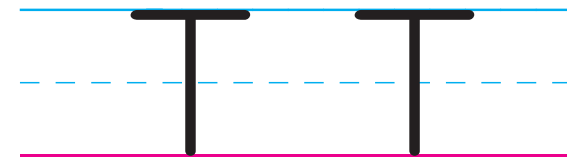
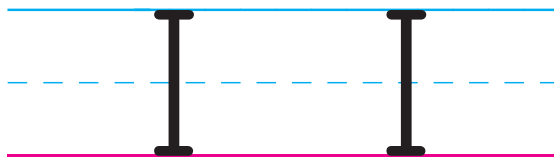
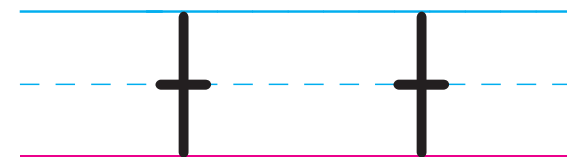
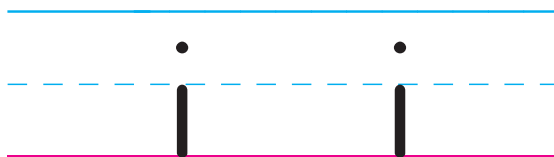
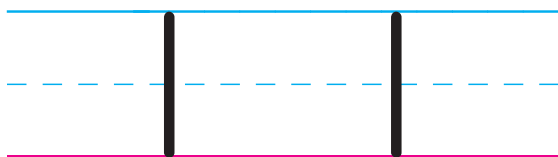

Write the Alphabet

Write the missing uppercase letters.

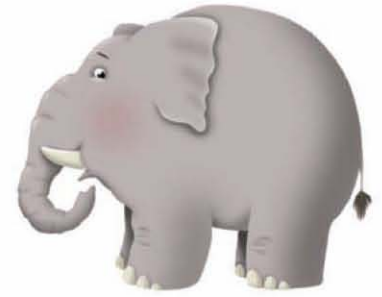

A

B

C

D

E

F

G

H

I

J

K

L

M

N

O

P

Q

R

S

T

U

V

W

X

Y

Z

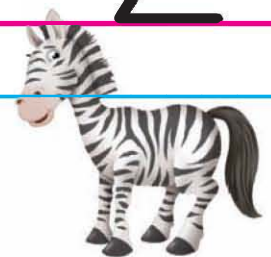

Happy Thought

The world is so full of a
number of things,
I'm sure we should all be
as happy as kings.

Robert Louis Stevenson

Write Words



Write the words.

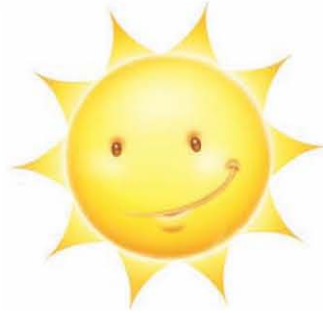

dog

cat

sun

pig

Write Sentences



Write the sentences.

One dog plays piano.

Three dogs sing.